



Electrolux
PROFESSIONAL

PLUS - Static Preparation 1400 mm Sink Cupboard with 2 Bowls

ITEM # _____

MODEL # _____

NAME # _____

SIS # _____

AIA # _____



134138 (GLG1426P)

Sink Cupboard with 2 bowls,
1400mm

Short Form Specification

Item No. _____

Enhanced stability and solid construction thanks to the welded frame and legs. The 50mm high worktop in 304 AISI stainless steel, with Scotch Brite finishing 10/10 mm in thickness, has anti-drip edges, welded corners and overflow rim along the top. 2 welded and polish sink bowls in 304 AISI stainless steel supplied with overflow pipe and 2" drain hole. Upstand h=100mm with 10mm radius corner covered on the back with AISI 304 stainless steel spot welded profile. Square section legs and height adjustable feet (-20 +30 mm) in 304 AISI stainless steel. 40 mm-thick lower welded shelf in AISI 304 stainless steel slots easily into place at a height of 200 mm from the floor (compulsory to install the chest of drawers). Square section legs and height adjustable feet (-20 +30 mm) in 304 AISI stainless steel.

Main Features

- Enhanced stability and solid construction. Stability, loading and stress tests by external certified body.
- Product range suitable for international tenders requirements for intense usage installations.

Construction

- Welded frame and legs.
- Worktop with 50mm high profile, is in stainless steel Scotch Brite finishing, 10/10 in thickness with anti-drip edges and welded corners and overflow rim along the top.
- Constructed entirely in 304 AISI stainless steel.
- Sink bowl is sound-deadened, in polish stainless steel overflow pipe and 2" drain hole.
- Drainers are sound-deadened with stainless steel reinforcement bars.
- Upstand back completely covered with Stainless Steel welded profile.
- Sliding doors are in stainless steel and double-walled with sound-deadening material inside. They are 7/10mm in thickness with roll bearings and end limit stop.
- Door sliding system is fluent and reliable, tested with over 80.000 cycles by external certified body.
- Cupboard interior has easy access thanks to completely openable doors.
- Base panel has 40mm high profile, is 8/10 in thickness with upturned edges and bar reinforcement.
- Height-adjustable stainless steel feet (-20/+30mm).

Optional Accessories

- Double plastic drain syphon 2 " for sinks PNC 850022
- Set of 4 wheels (2 with brake), diameter=125mm PNC 855207
- Single plastic drain syphon 2 " for Sinks PNC 895313

APPROVAL: _____



Experience the Excellence
www.electroluxprofessional.com

Key Information:

External dimensions, Width:	1400 mm
134138 (GLG1426P)	
External dimensions, Depth:	700 mm
External dimensions, Height:	1000 mm
Upstand Dimensions, Height:	100 mm
Upstand Dimensions, Depth:	13 mm
Upstand Dimensions, Radius:	R=10
Bowls number	2
Bowl dimensions	600x500xH300
Worktop thickness:	50 mm
Net weight:	60 kg

Front

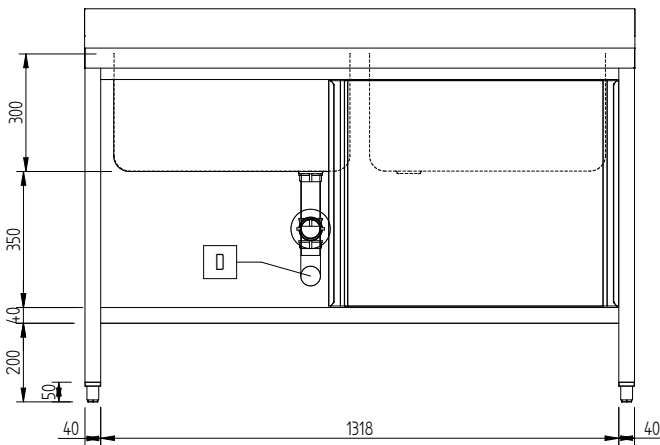

Side

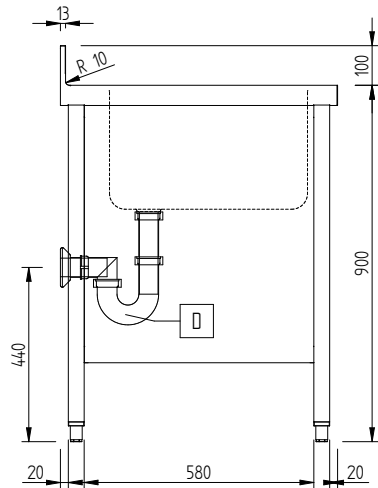

Top

